

SERVICE INFORMATION DIRECTIVE
Compliance Will Enhance Safety, Maintenance or Economy of Operation

SID 05-1

Technical Portions FAA Approved

SUBJECT: THIS SERVICE INFORMATION DIRECTIVE (SID) SUMMARIZES INFORMATION PERTINENT TO THE DESIGN, OPERATION, MAINTENANCE AND WARRANTY FOR TCM CAMSHAFTS AND HYDRAULIC LIFTERS

PURPOSE: 1) To provide information on the operation and material of the cam and lifters.
 2) To provide information to determine if inspection is required.
 3) To assist with inspection criteria if any inspection is indicated.
 4) To update TCM's warranty policy if cam and lifter component issues are determined

COMPLIANCE: TCM recommends inspection described only if the indications defined are found. In the absence of such indications, no action is needed or recommended.

MODELS AFFECTED: All TCM engine models

INTRODUCTION

DESIGN

The camshaft in TCM engines is located below the crankshaft and is driven by a gear set from the crankshaft at one-half the speed of the crankshaft. The lobes on the cam control valve lift and duration. The links between the cam and the valves are the hydraulic lifters, the push rods and the rocker arms.

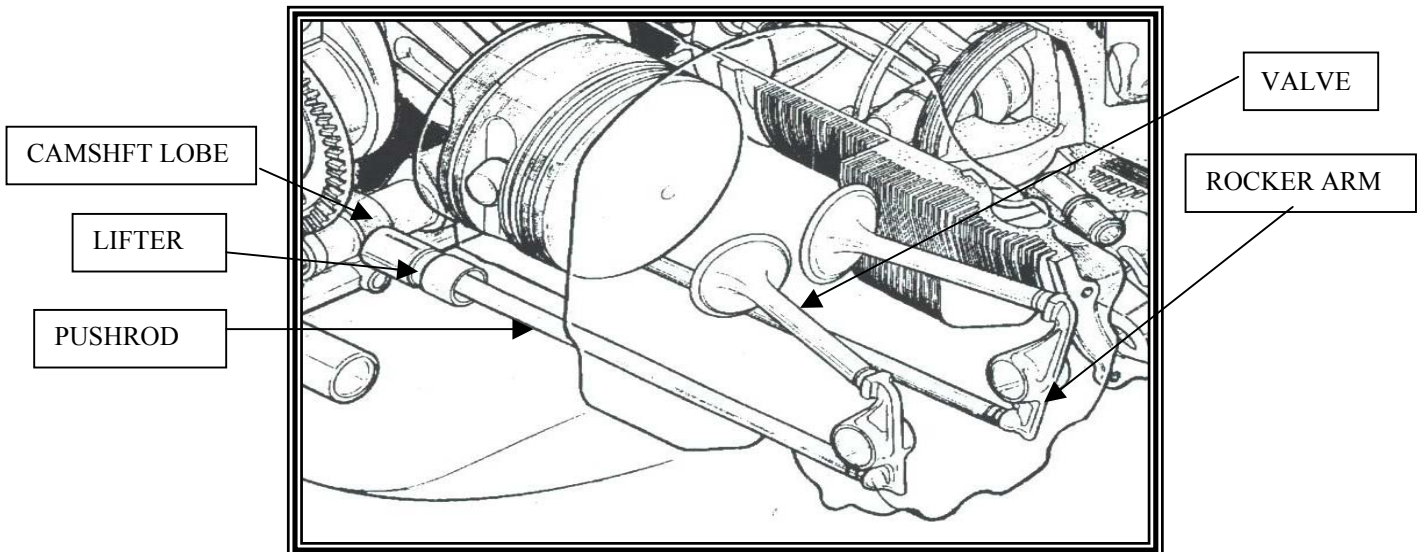

FIGURE 1: VALVE GEAR SCHEMATIC

ISSUED			REVISED			PAGE NO	REVISION
MO	DAY	YEAR	MO	DAY	YEAR		
01	04	2005				1 of 12 SID 05-1	



Teledyne Continental Motors, Inc.

A Teledyne Technologies Company

P.O. Box 90 Mobile Alabama • 251-438-3411

The hydraulic lifter performs two functions. First, it provides an interface between the camshaft lobe and the remaining valve train. This allows conversion of the cam lobe profile into a linear movement for actuation of the intake and exhaust valves. Secondly, the hydraulic mechanism inside the lifter maintains zero clearance between the valve and it's actuating components

The loads on the lifter are a result of the force of the cam lift against the valve springs and the inertia of the components. This load transfers between the cam face and the lifter face over a small area with some sliding occurring between the two surfaces. High contact stresses are generated and are countered by use of very hard materials with splash oil present to reduce friction. The face of the lifter has a small curvature or crown, and the cam lobe has a slight taper. This results in the contact point being off-center of the lifter and causes the lifter to rotate during operation, avoiding single point contact between the lifter and the camshaft lobe.

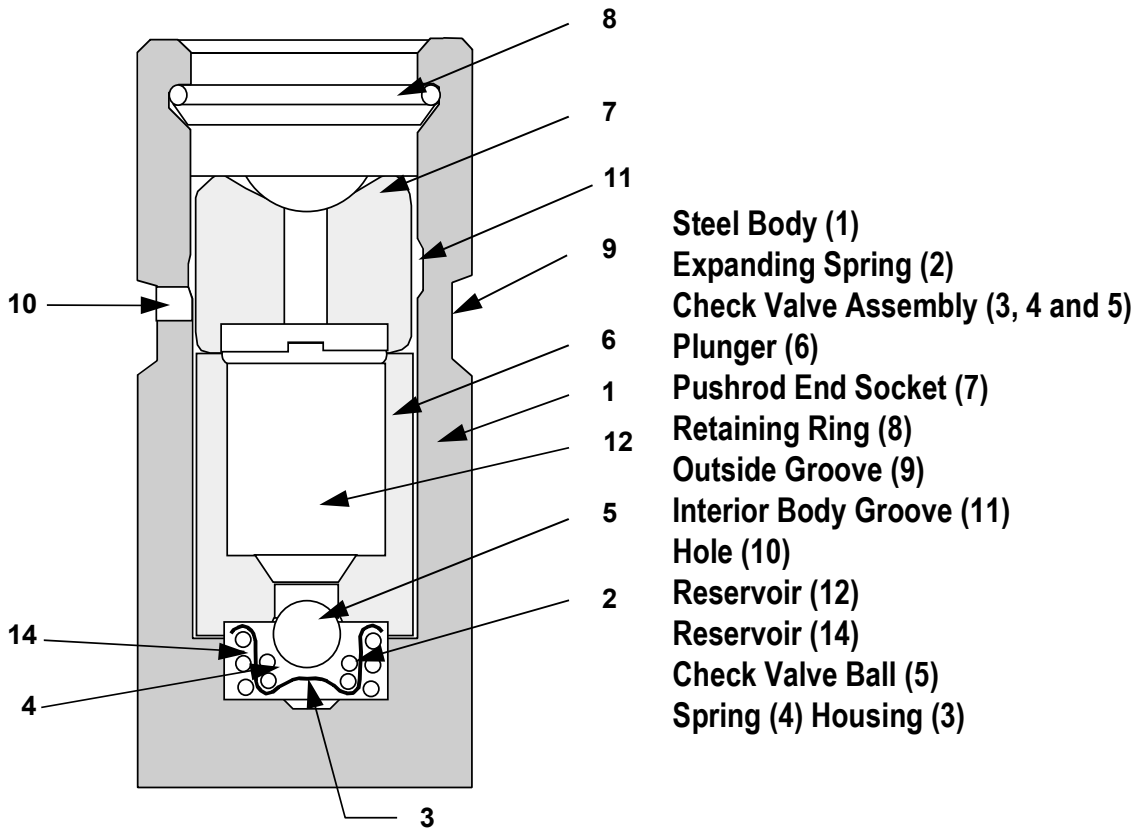

FIGURE 2 HYDRAULIC LIFTER CROSS SECTION

ISSUED			REVISED			 Teledyne Continental Motors, Inc. <small>A Teledyne Technologies Company</small> P.O. Box 90 Mobile Alabama • 251-438-3411	PAGE NO	REVISION
MO	DAY	YEAR	MO	DAY	YEAR		2 of 12	
01	04	2005				SID 05-1		



FIGURE 3 CAM AND LIFTER INTERFACE

MATERIALS

The material of the cam is aircraft quality steel with the cam lobes carburized for additional hardness and wear resistance. During manufacture, the lobes are also coated with a manganese phosphate coating to resist rust and lower friction during the initial hours of engine operation.

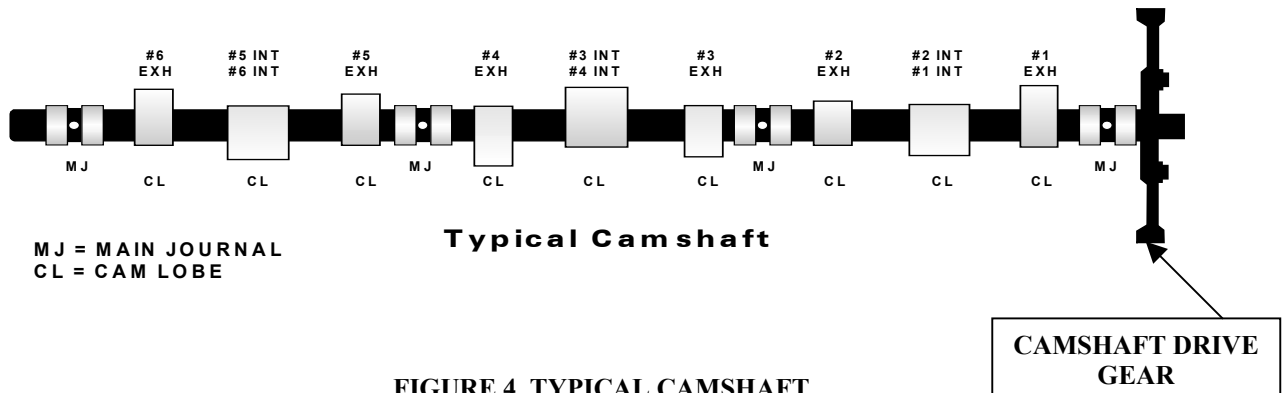

FIGURE 4 TYPICAL CAMSHAFT

The lifter body is made of cast iron with the face being “chilled” during casting. The chilled cast iron face has areas of extremely hard wear resistant material, iron carbides, surrounded by a softer matrix of iron. This combination provides excellent wear characteristics under high contact stress situations such as the cam-lifter interface. The face of the lifter is also manganese phosphate coated for the same reasons as the cam lobes.

ISSUED			REVISED			 Teledyne Continental Motors, Inc. <small>A Teledyne Technologies Company</small> P.O. Box 90 Mobile Alabama • 251-438-3411	PAGE NO	REVISION
MO	DAY	YEAR	MO	DAY	YEAR		3 of 12	
01	04	2005				SID 05-1		

This combination of materials has been used by TCM for many years on all of our engines. Other aircraft engine producers use very similar materials.

WEAR MECHANISMS

The interface between a cam lobe and lifter is intended to wear to some degree as the engine operates. This is similar to the piston ring / cylinder wall interface that must seat together for proper operation and wear over time. The manganese phosphate will quickly wear off in loaded areas of the cam lobe and the lifter face. Normal wear may take the form of a bright shiny uniform wear surface, with a circular pattern visible on the lifter face. Damage to the lifters is often referred to as “galling” or “spalling”. Localized areas may show signs of spalling or galling in service due to various operating conditions. Some level of such conditions will frequently be found at overhaul. Note that this wear material as with all other normal wear material will be collected by the oil and trapped in the oil filter element or screen



FIGURE 5 TYPICAL LIFTER FACES FROM SERVICE

Galling results from a breakdown in lubrication allowing bare metal to metal contact. Bonding of one of the materials to the other can result, transferring a small amount of material. The transferred material may cause a high stress region and can lead to spalling. In spalling, high contact stresses induce cracks in the softer matrix around the iron carbides in the lifter face. This type of damage appears as a small area of the lifter face that has separated leaving a small hole. This type of distress occurs due to the chilled iron face having regions of high hardness in a matrix of softer material. Under high loads and with stress concentrations, small sections of the softer material may fatigue and separate from the harder material.

Since the camshaft is steel and the lifter body is iron, rust or corrosion is by far the most common reason for lifters to spall. The pits caused by corrosion are stress concentrations that result in spalling.

ISSUED			REVISED			 Teledyne Continental Motors, Inc. <small>A Teledyne Technologies Company</small> P.O. Box 90 Mobile Alabama • 251-438-3411	PAGE NO	REVISION
MO	DAY	YEAR	MO	DAY	YEAR		4 of 12	
01	04	2005				SID 05-1		

Foreign material between the cam lobe and lifter can result in very high local loads on the surfaces and break down a local area of the lifter.

Foreign material may also stop a lifter from rotating in the bore. This results in one area being loaded constantly and can also lead to spalling.

Manufacturing issues such as not having the correct dimensions have the potential to result in spalling.

Material issues with the lifter body can effect the chilled area adversely leading to spalling as well.

WEAR EFFECTS

The cam lobe / lifter interface is designed to wear to some extent during service life and the lifter and cam lobe “break in” together similar to piston rings in a cylinder bore. Such wear is normal as are circular wear patterns on the face of the lifter and polishing of the cam lobes. Circular scratches may also result from hard particle passage and will not effect operation.

Minor spalling due to corrosion or other factors will not affect operation as the loads are redistributed to the surrounding material. The appearance will be some number of separated spalled areas with polished contact patterns on the remainder of the face. (Reference Figure 6)



FIGURE 6 MINOR SPALLING

Major spalling that involves much of the face will also usually have no effect on operation and will also frequently “heal over” and re-establish a stable surface for the cam interface. The effect on the cam is minimal. Note that the hydraulic feature of the lifter continuously adjusts for any wear and keeps valve operation normal.

The material from such spalling is small and drops into the oil sump when generated and is captured in the oil filter element or screen

ISSUED			REVISED			 Teledyne Continental Motors, Inc. <small>A Teledyne Technologies Company</small> P.O. Box 90 Mobile Alabama • 251-438-3411	PAGE NO	REVISION
MO	DAY	YEAR	MO	DAY	YEAR		5 of 12	
01	04	2005				SID 05-1		

In very rare cases, the lifter deterioration will cause significant wear to the cam lobe. In such cases, the lift of the valve may be reduced. Initially, the effect on performance would be negligible, but may eventually lead to reduction of power of the cylinder effected. Valve lift is in the order of one-half inch so the wear would have to be extreme to noticeably effect cylinder performance. Note that the hydraulic lifter has a limited range of hydraulic adjustment and would run out of travel before extreme wear occurred. This could result in an audible tapping noise from the engine.

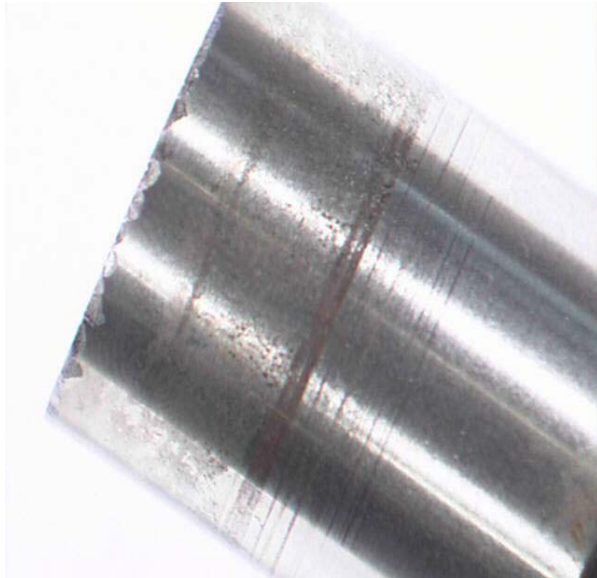

CORROSION ETCHING ON BODY



FULL FACE SPALLING

FIGURE 7 LIFTER CORROSION AND SIGNIFICANT SPALLING

In some cases, significant spalling may result in some damage to the cam lobe apex. This level of damage is rare, but will manifest itself as surface cracks on the nose with some depth. Note that appearance of the cam lobe apex may vary normally, and only if such cracks are present should the camshaft be considered a candidate for replacement. Corrosion (rust) will also cause cam lobe distress. See the INSPECTION SECTION for specifics.

CAM-LIFTER DISTRESS DETECTION

As with other wearing parts in the engine, the normal means of detecting excessive wear are by oil analysis, examination of the oil filter element or screen at each oil change, and for engines with oil suction screens and/or magnetic drain plugs, examination of those screens and/or plugs for iron or steel. Extreme wear may be detected by audible noise from the valve train. Such noise may also indicate a lifter that is not pumping up properly to take up system lash rather than wear. **IN THE ABSENCE OF SUCH INDICATIONS, NO ACTION IS NEEDED.**

If an abnormal amount of iron material is observed in the filter and believed to be from the lifters, an inspection may be carried out as detailed in lifter and cam lobe inspection section.

ISSUED			REVISED			 Teledyne Continental Motors, Inc. <small>A Teledyne Technologies Company</small> P.O. Box 90 Mobile Alabama • 251-438-3411	PAGE NO	REVISION
MO	DAY	YEAR	MO	DAY	YEAR		6 of 12	
01	04	2005				SID 05-1		

CAM-LIFTER DISTRESS PREVENTION

Issues related to corrosion such as the majority of the cam-lifter reports can be reduced by frequent flight operation with the oil up to normal temperatures. A minimum of 30 minutes cruise flight after oil temperatures are stable (in the 170°F to 200°F range) is needed. Such use keeps lubrication on the parts and helps to remove moisture and acids from the oil. Any initial corrosion on cylinder bores or the cam lobe-lifter interference is eliminated before etching pits into the surface. As a result of such frequent operation, fleet operators rarely experience such corrosion and subsequent cam lobe / lifter distress issues. Unfortunately, this may not be possible for aircraft that are infrequently flown. It is especially important for infrequently flown aircraft to have frequent oil changes. TCM recommends that aircraft that are not flown on a regular basis have the oil and filter changed at least four times a year. Oil changes are needed not because the oil is "breaking down" but to eliminate wear particles, combustion by-products, moisture and acid buildup in the oil. Clean oil should be installed and the aircraft flown prior to significant periods of inactivity. Also, the instructions in TCM Service Bulletin SIL99-1, Engine Preservation For Active and Stored Aircraft must be followed.

Pre-heating using crankcase heaters is an effective means of warming an engine. However, the warming and cooling process can also condense moisture into the oil aggravating corrosion issues. See the latest revision of TCM bulletin SIL03-1 Cold Weather Operation – Engine Pre-Heating for more information on this subject.

Various types of oils are approved for use in the engines. All provide good lubrication under normal operation. There are differences in the tendency to retain moisture and to scavenge lead and other combustion products between straight oil and multi-viscosity oil and between mineral oil and semi-synthetics. No conclusive evidence is known correlating these characteristics to the incident rate of cam-lifter reports.

LIFTER AND CAM LOBE INSPECTION

If abnormal amounts of iron/steel are detected by oil analysis, oil filter element or screen examination, oil suction screen examination, or drain plug examination, the lifters and cam lobes may be examined as described below. **No examination is needed in the absence of such indicators or audible noise from the valve gear.**

INSPECTION

- (1) Using the airframe manufacturers maintenance instructions remove engine cowlings and cooling baffles as necessary to gain access to the cylinders for valve cover removal.

Using the appropriate engine overhaul or maintenance manual, remove the lifters as follows:

WARNING

VERIFY MASTER SWITCH IS IN THE "OFF" POSITION AND MAGNETO SWITCHES ARE CONNECTED TO THE MAGNETOS, THAT THEY ARE IN THE "OFF" POSITION AND "P" LEADS ARE GROUNDED WHILE WORKING IN CLOSE PROXIMITY TO THE PROPELLER.

- (2) Remove valve covers from the cylinders.
- (3) Position the crankshaft so that the valves of the cylinder being worked are fully closed.
- (4) Remove rocker shaft retaining hardware, rocker shafts, rocker arms and thrust washers (as required). Discard tab lock washers (Where used) Mark the removed parts for re-installation in the position from which they were removed.
- (5) Remove the pushrods. Mark the removed pushrods and for reinstallation into the position from which they were removed and mark their installed orientation.

ISSUED			REVISED			PAGE NO	REVISION
MO	DAY	YEAR	MO	DAY	YEAR		
01	04	2005				7 of 12 SID 05-1	



Teledyne Continental Motors, Inc.
A Teledyne Technologies Company
P.O. Box 90 Mobile Alabama • 251-438-3411

- (6) Compress the pushrod housing against the spring until the outboard end is clear. Drop the cylinder flange end of the pushrod housing until it is clear of the cylinder and then remove the housing from the crankcase.

NOTE

Some engine configurations allow removal of the pushrod housing through the cylinder head flange. These configurations may be identified by the presence of two pushrod housing washers on either side of the pushrod housing seal installed in the cylinder head. After removal of the pushrod housing seals and washers from the cylinder head, the pushrod tube may then be removed through the cylinder head. On engine models not incorporating this design, removal of induction system components may be required to facilitate pushrod tube removal.

- (7) Remove the hydraulic lifter assemblies from the lifter bores. Mark the lifters for reinstallation into the position from which they were removed.
- (8) If the lifter face and body shows normal signatures, coat with Dow-Corning® G-N paste and reinstall in the same location as removed.
- (9) Reinstall items removed in steps 1 through 6 above (using new tab washers as applicable) using the latest revision of the appropriate maintenance or overhaul manual and the latest revision of Service Bulletin SB96-7 Torque Limits.

Replace lifters with severe face or lifter body wear signatures or spalling that exceeds 10% of the surface area. Lifters associated with noise indicating excessive valve lash should also be replaced regardless of face condition.



FIGURE 8 ACCEPTABLE LIFTER FACE SIGNATURE

ISSUED			REVISED			 Teledyne Continental Motors, Inc. <small>A Teledyne Technologies Company</small> P.O. Box 90 Mobile Alabama • 251-438-3411	PAGE NO	REVISION
MO	DAY	YEAR	MO	DAY	YEAR		8 of 12	
01	04	2005				SID 05-1		



FIGURE 9 REPLACEMENT SIGNATURES, SPALLED LIFTER

If a lifter must be replaced following the inspection criteria and Figures 10 - 12, inspect the associated cam lobe as follows:

WARNING

VERIFY MASTER SWITCH IS IN THE "OFF" POSITION AND MAGNETO SWITCHES ARE CONNECTED TO THE MAGNETOS, THAT THEY ARE IN THE "OFF" POSITION AND "P" LEADS ARE GROUNDED WHILE WORKING IN CLOSE PROXIMITY TO THE PROPELLER.

- (1) Turn engine so that the apex of the cam lobe is visible through the lifter bore in the crankcase, reference Figure 10.



FIGURE 10 CAM LOBE APEX IN INSPECTION LOCATION
(Normal wear signature shown)

ISSUED			REVISED			PAGE NO	REVISION
MO	DAY	YEAR	MO	DAY	YEAR		
01	04	2005				9 of 12 SID 05-1	



Teledyne Continental Motors, Inc.
A Teledyne Technologies Company
P.O. Box 90 Mobile Alabama • 251-438-3411

(2) Perform visual inspection using an inspection light. If the surface is smooth and shiny with only small areas of rough appearance, no further action is required.



CAM LOBE OPENING FACE



APEX OF CAM LOBE



CAM LOBE CLOSING FACE

FIGURE 11 TYPICAL CAM LOBE WEAR SIGNATURES

ISSUED			REVISED			PAGE NO	REVISION
MO	DAY	YEAR	MO	DAY	YEAR		
01	04	2005				10 of 12 SID 05-1	



Teledyne Continental Motors, Inc.
A Teledyne Technologies Company
P.O. Box 90 Mobile Alabama • 251-438-3411

(3) If the visual inspection indicates the presence of crack like features in the surface along the cam lobe apex, proceed as follows:

Using a sharp pick, move the point over the nose. If a crack like feature has any depth, the pick will catch in the groove or pits. If no positive indication of a crack is felt, no further action is required. If an indentation is present, the cam must be examined by a TCM service representative to determine the next steps.

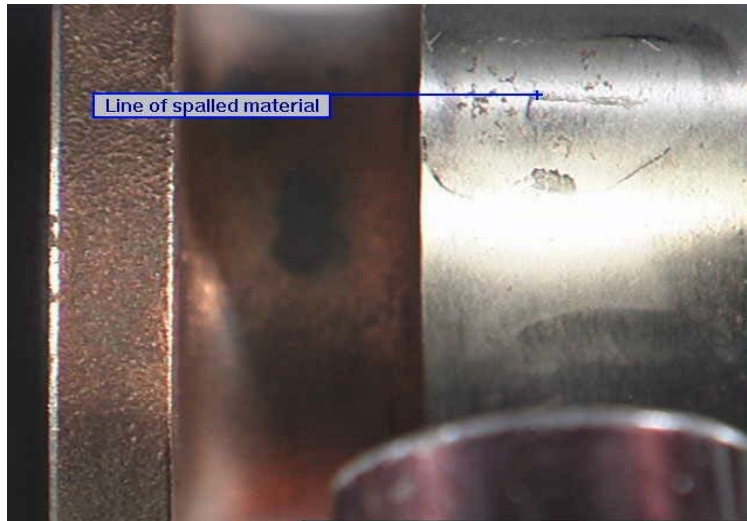

SPALLED CAM LOBE

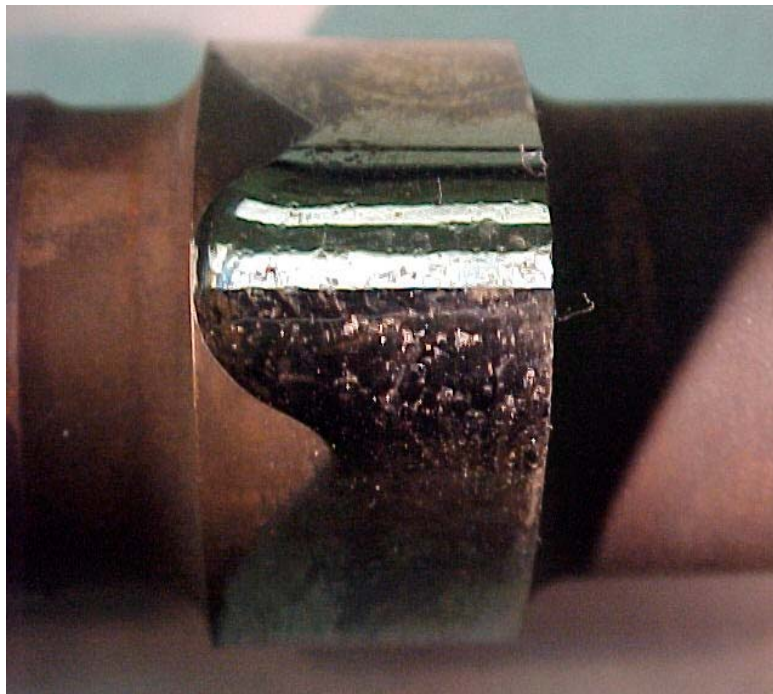

CORROSION PITTED CAM LOBE

FIGURE 12 SUSPECT CAM LOBE APEX SIGNATURES

ISSUED			REVISED			 Teledyne Continental Motors, Inc. <small>A Teledyne Technologies Company</small> P.O. Box 90 Mobile Alabama • 251-438-3411	PAGE NO	REVISION
MO	DAY	YEAR	MO	DAY	YEAR		11 of 12 SID 05-1	
01	04	2005						

NOTE
CONTACT TCM SERVICE DEPARTMENT TO ARRANGE EXAMINATION OF THE
SUSPECTED AREA BY A TCM SERVICE REPRESENTATIVE.

For minor distress, the camshaft may be continued in service and re-examined upon the accumulation of 100 hours operation or 12 months, whichever occurs first. If the TCM representative determines the camshaft should be replaced, the engine should be removed for repair. Note that cylinder removal to gain better access may be required to make the final determination.

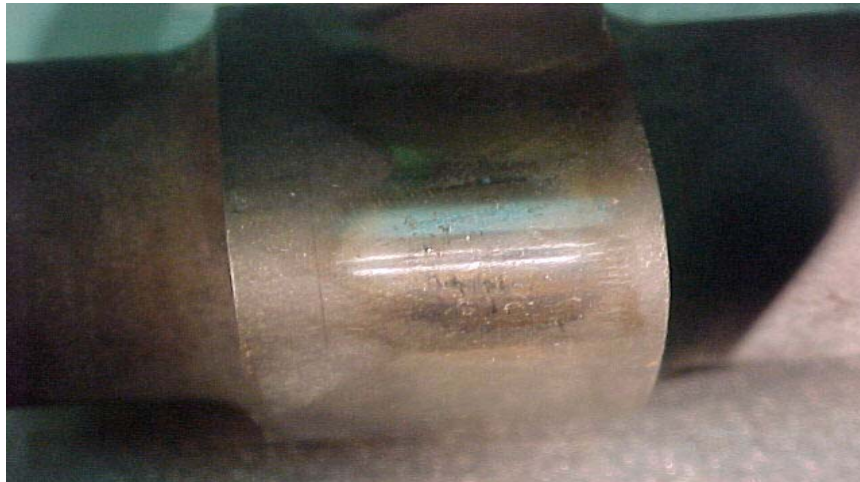

FIGURE 13 CAM LOBE APEX MINOR DISTRESS

SUMMARY

This bulletin contains the Instructions for Continued Airworthiness to inspect lifters and their associated camshaft lobes on in-service engines. TCM considers lifters to be a 100% replacement item at overhaul.

WARRANTY

For warranty information and coverage, refer to the Warranty supplied with your engine or contact TCM. TCM warranty will cover replacement of lifters and cam where distress is found, in accordance with the applicable warranty policy in effect on the engine at the date of occurrence, except as noted below:

- (1) TCM warranty does not cover lifter or cam replacement required due to distress originating from corrosion or lack of lubrication.
- (2) TCM warranty will not cover lifter or cam replacement unless authorized by a TCM Service Representative prior to the work being done.
- (3) TCM may require the inspections or repair be done at facilities selected by TCM.
- (4) TCM warranty will not cover inspection for such conditions in the absence of the indications described in this bulletin.

ISSUED			REVISED			 Teledyne Continental Motors, Inc. <small>A Teledyne Technologies Company</small> P.O. Box 90 Mobile Alabama • 251-438-3411	PAGE NO	REVISION
MO	DAY	YEAR	MO	DAY	YEAR		12 of 12	
01	04	2005				SID 05-1		